

# Supplement

Title: 33XR-A Users      Supplement Issue: 1  
Part Number: 2728921      Issue Date: 9/06  
Print Date: July 2006      Page Count: 1  
Revision/Date:

---

---

This supplement contains information necessary to ensure the accuracy of the above manual.

# Change #1

On page 9, under **General Specification**, change **Operating environment**:

From: 0 °C to 50 °C at <70% R.H.

To: 0 °C to 50 °C at <70% R.H. for all functions  
except 10A ranges

10A ranges: 0 °C to 40 °C at <70% R.H.



**33XR-A**

# Professional Digital Multimeter

with Temperature  
and Capacitance

## Users Manual

- Mode d'emploi
- Bedienungshandbuch
- Manuale d'Uso
- Manual de uso

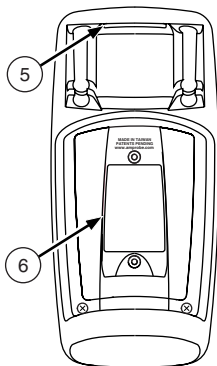
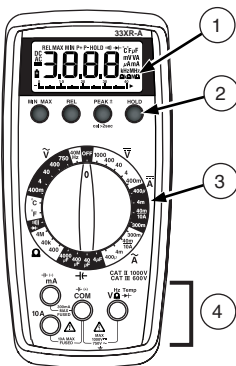

**1. Display**

Afficheur  
Anzeige  
Display  
Pantalla

**5. Strap Clip**

Clip de bretelle  
Klemme  
Clip in velcro  
Clip para correa

**2. Feature Buttons**

Boutons de fonctions  
Funktionstasten  
Pulsanti delle funzioni  
Botones de función

**6. Battery/Fuse Cover**

Capot des fusibles/pile  
Batterie-/Sicherungsabdeckung  
Sportello del vano portapile/fusibili  
Puerta de la batería y el fusible

**3. Function/Range Switch**

Commutateur de gamme/fonction  
Funktion/Bereich-Schalter  
Selettore funzione/portata  
Selector de la función y del rango

**4. Test Lead Connections**

Branchements des cordons de test  
Messleitungsanschlüsse  
Boccole per i cavetti  
Conexiones de los conductores de prueba

**33XR-A**



# **33XR-A**

## **Professional Digital Multimeter**

### **Users Manual**

- **Mode d'emploi**
- **Bedienungshandbuch**
- **Manuale d'Uso**
- **Manual de uso**

PN 2728921

July 2006

©Amprobe® Test Tools.

All rights reserved. Printed in Taiwan.



# 33XR-A Digital Multimeter

## Contents











⚠ ⚠ Safety Information.....	2
Introduction.....	3
Making Measurements.....	3
Verify Instrument Operation.....	3
Correcting an Overload (OL) Indication.....	3
Measuring DC Voltage..... See Figure -1-	3
Measuring AC Voltage..... See Figure -2-	3
Preparing for Current Measurements.....	3
Measuring DC Current..... See Figure -3-	4
Measuring AC Current..... See Figure -4-	4
Measuring Resistance..... See Figure -5-	4
Measuring Continuity..... See Figure -6-	4
Checking Diodes..... See Figure -7-	4
Measuring Capacitance..... See Figure -8-	5
Measuring Temperature..... See Figure -9-	5
Measuring Frequency..... See Figure -10-	5
Additional Features.....	5
Input Test Lead Warning.....	5
MIN MAX Measurements.....	5
Peak Hold Measurements.....	6
Auto Power Off.....	6
Relative Measurements.....	6
HOLD Measurements.....	6
Product Maintenance.....	7
Cleaning.....	7
Troubleshooting.....	7
Battery and Fuse Replacement..... See Figure -11-	7
Repair.....	7
WARRANTY.....	8
Specifications.....	9

## Safety Information

To avoid electric shock, personal injury, damage to the meter or the equipment under test, adhere to the following practices:

- The 33XR-A Digital Multimeter is UL, cUL, and EN61010-1 certified for Installation Category III – 600V and Category II – 1000V. It is recommended for use with local level power distribution, appliances, portable equipment, etc, where only smaller transient overvoltages may occur, and not for primary supply lines, overhead lines and cable systems.
- Do not exceed the maximum overload limits per function (see specifications) nor the limits marked on the instrument itself. Never apply more than 1000 V dc/750 V ac between the test lead and earth ground.
- Inspect DMM, test leads and accessories before every use. Do not use any damaged part.
- Never ground yourself when taking measurements. Do not touch exposed circuit elements or probe tips.
- Do not operate the instrument in an explosive atmosphere.
- Exercise extreme caution when measuring voltage >20 V // current >10 mA // AC power line with inductive loads // AC power line during electrical storms // current, when the fuse blows in a circuit with open circuit voltage >1000 V // servicing CRT equipment.
- Always measure current in series with the load – NEVER ACROSS a voltage source. Check fuse first. Never replace a fuse with one of a different rating.
- Do not change the position of the Function/Range Switch while the **MIN MAX**, **HOLD**, or **REL** feature is enabled. Erroneous readings will result.
- Remove test leads before opening battery or case to change battery or fuses.

## Symbols Used in this Manual

	Battery		Refer to the manual
	Double insulated		Dangerous Voltage
	Direct Current		Earth Ground
	Alternating Current		Audible tone
	Complies with EU directives		Underwriters Laboratories, Inc
	Fuse		

---

## Introduction

The 33XR-A is a manual ranging handheld digital multimeter for measuring or testing the following:

- DC and AC voltage
- DC and AC current
- Resistance
- Frequency
- Temperature
- Capacitance
- Diodes
- Continuity

Additional features include the following modes:

MIN MAX, HOLD, REL (relative), and Peak±

---

## Making Measurements

### Verify Instrument Operation

Before attempting to make a measurement, verify that the instrument is operational and the battery is good. If the instrument is not operational, have it repaired before attempting to make a measurement.

### Correcting an Overload (OL) Indication

An OL indication may appear on the display to indicate that an overload condition exists. For voltage and current measurements, an overload should be immediately corrected by selecting a higher range. If the highest range setting does not eliminate the overload, interrupt the measurement until the problem is identified and eliminated. The OL indication is normal for some functions; for example, resistance, continuity, and diode test.

### Measuring DC Voltage

See Figure -1-

1. Set the Range Switch to an appropriate  $\bar{v}$  range.  
Select the highest range and work down if the voltage level is unknown.
2. Connect the Test Leads: Red to  $V\Omega \rightarrow$ , Black to **COM**
3. Connect the Test Probes to the circuit test points.
4. Read the display, and, if necessary, fix any overload (OL) conditions.

### Measuring AC Voltage

See Figure -2-

1. Set the Range Switch to an appropriate  $\tilde{v}$  range.  
Select the highest range and work down if the voltage level is unknown.
2. Connect the Test Leads: Red to  $V\Omega \rightarrow$ , Black to **COM**
3. Connect the Test Probes to the circuit test points
4. Read the display, and, if necessary, fix any overload (OL) conditions.

### Preparing for Current Measurements

- Turn off circuit power before connecting the test probes.
- Allow the meter to cool between measurements if current measurements approach or exceeds 10 amps.
- A warning tone sounds if you connect a test lead to a current input before you select a current range.
- Open circuit voltage at the measurement point must not exceed 1000 V.
- Always measure current in series with the load. Never measure current across a voltage source.

## Measuring DC Current

See Figure -3-

1. Set the Range Switch to an appropriate  $\bar{A}$  range.  
Select the highest range and work down if the current level is unknown.
2. Connect the Test Leads: Red to **mA** or **10 A**, Black to **COM**
3. Turn off power to the circuit being measured.
4. Open the test circuit ( $\rightarrow X \leftarrow$ ) to establish measurements points.
5. Connect the Test Probes in series with the load.
6. Turn on power to the circuit being measured.
7. Read the display, and, if necessary, fix any overload (**OL**) conditions.

## Measuring AC Current

See Figure -4-

1. Set the Range Switch to an appropriate  $\tilde{A}$  range.  
Select the highest range and work down if the current level is unknown.
2. Connect the Test Leads: Red to **mA** or **10 A**, Black to **COM**
3. Turn off power to the circuit being measured.
4. Open the test circuit ( $\rightarrow X \leftarrow$ ) to establish measurements points.
5. Connect the Test Probes in series with the load.
6. Turn on power to the circuit being measured.
7. Read the display, and, if necessary, fix any overload (**OL**) conditions.

## Measuring Resistance

See Figure -5-

1. Set the Range Switch to an appropriate  $\Omega$  range.  
Select the highest range and work down if the resistance level is unknown.
2. Connect the Test Leads: Red to **V  $\Omega$   $\rightarrow$** , Black to **COM**
3. Turn off power to the circuit being measured. Never measure resistance across a voltage source or on a powered circuit.
4. Discharge any capacitors that may influence the reading.
5. Connect the Test Probes across the resistance.
6. Read the display. If **OL** appears on the highest range, the resistance is too large to be measured.

## Measuring Continuity

See Figure -6-

1. Set the Range Switch to  $\rightarrow \parallel$ .
2. Connect the Test Leads: Red to **V  $\Omega$   $\rightarrow$** , Black to **COM**
3. Turn off power to the circuit being measured.
4. Discharge any capacitors that may influence the reading.
5. Connect the Test Probes across the resistance.
6. Listen for the tone that indicates continuity ( $< 35 \Omega$ ).

## Checking Diodes

See Figure -7-

1. Set the Range Switch to  $\rightarrow \rightarrow$ .
2. Connect the Test Leads: Red to **V  $\Omega$   $\rightarrow$** , Black to **COM**
3. Turn off power to the circuit being measured.
4. Free at least one end of the diode from the circuit.
5. Connect the Test Probes across the diode.
6. Read the display. A good diode has a forward voltage drop of about 0.6 V. An open or reverse biased diode will read **OL**.

## Measuring Capacitance

See Figure **-8-**

1. Set the Range Switch to **←**.
2. Connect the Test Leads: Red to **COM**, Black to **mA**
3. Turn off power to the circuit being measured.
4. Discharge the capacitor using a 100 k $\Omega$  resistor.
5. Free at least one end of the capacitor from the circuit.
6. Connect the Test Probes across the capacitor. When measuring an electrolytic capacitor match the test lead polarity to the polarity of the capacitor.
7. Read the display.

## Measuring Temperature

See Figure **-9-**

1. Set the Range Switch to **°C** or **°F**.
2. Connect a TEMP adapter plug (XR-TA) to the **V  $\Omega$  →** and **COM** inputs.
3. Connect the K-type thermocouple to the TEMP adapter.  
Match the polarity of the adapter to the polarity of the thermocouple.  
*Note: Thermocouple is not intended for contact with liquids or electrical circuits.*
4. Expose the thermocouple probe to the temperature to be measured.
5. Read the display.

## Measuring Frequency

See Figure **-10-**

1. Set the Range Switch to **1 MHz**.
2. Connect the Test Leads: Red to **Hz**, Black to **COM**
3. Connect the Test Probes to the signal source.
4. Read the display. The Meter will autorange for the best resolution.

---

## Additional Features

### Input Test Lead Warning

The meter emits a continuous tone when a test lead is placed in the **mA** or **10 A** input jack and the selector switch is not set to a correct current range. (If the DMM is connected to a voltage source with its leads connected for current, very high current could result). All current ranges are protected by fast acting fuses.

### MIN MAX Measurements

#### **WARNING**

**To avoid erroneous readings, do not change the position of the Function/Range Switch while the MIN MAX function is enabled.**

The MIN MAX function reads and updates the display to show the maximum or minimum value measured after you press the **MIN MAX** button.

Pressing the **MIN MAX** button for less than 1 second will put the meter into a mode of displaying the maximum, minimum, or actual readings. Each time the button is pressed, the meter will cycle to the next display mode as shown in the table below. Press the **MIN MAX** button for more than 2 seconds to disable this feature.

Button	Display	Value Displayed
< 1 second	<b>MAX</b>	Maximum value after feature activated
< 1 second	<b>MIN</b>	Minimum value after feature activated
< 1 second	<b>MIN MAX</b> (blinks)	Actual input after feature activated
> 2 seconds	Exit function	

## Peak Hold Measurements

*Note: The PEAK function must be calibrated to meet the specifications.*

Peak Hold records and stores the positive and negative peak values that occur while measuring an ac signal. To calibrate the Peak Hold function press the **PEAK** button for more than 2 seconds. The display will show CAL when the calibration cycle is done. Press the **PEAK** button again for the maximum (P+) and minimum (P-) peak values for the ac signal being measured. The display will toggle between the P+ and P- readings each time the **PEAK** button is pressed. Press the **PEAK** button for more than 1 second to exit the PEAK function.

## Auto Power Off

Auto Power Off is a battery saving feature that puts the meter into a sleep mode if the Function/Range Switch has not changed position in the last 30 minutes. To wake the meter turn it off and then on.

The Auto Power Off feature can be disabled to keep the meter from going to sleep. This feature is useful when using the MIN MAX mode for extended periods. To disable the Auto Power Off feature use the following procedure:

1. Set the Function Switch to **OFF**.
2. Press and hold the **MIN MAX** button while turning the Function Switch to the desired function.
3. Continue to press the **MIN MAX** button until the display finishes this initialization period and the reading settles.
4. Release the **MIN MAX** button. The Auto Power Off feature will remain disabled until the meter is turned off and then on.

## Relative Measurements

### **WARNING**

**To avoid erroneous readings, do not change the position of the Function/Range Switch while the REL function is enabled.**

The Relative mode displays the difference between the actual reading and a reference value. It may be used with any function or range. To make a relative measurement establish a reference value by measuring a value and then pressing the **REL** button after the reading has stabilized. This stores the measured value as the reference and sets the display to zero. The meter subtracts the reference value from subsequent measurements and displays this difference as the relative value. Measurement values greater than the reference value will be positive and values less than the reference value will be negative.

To exit the Relative Mode, Press and hold the **REL** button for 2 seconds.

## HOLD Measurements

### **WARNING**

**To avoid erroneous readings, do not change the position of the Function/Range Switch while the HOLD function is enabled.**

The **HOLD** button causes the meter to capture and continuously display a measurement reading. To use the HOLD feature make a measurement, and then, after the reading has stabilized, momentarily press the **HOLD** button. You can remove the test leads and the reading will remain on the display. Pressing the **HOLD** button again releases the display.

---

## Product Maintenance

### Cleaning

To clean the meter, use a soft cloth moistened with water. To avoid damage to the plastic components do not use benzene, alcohol, acetone, ether, paint thinner, lacquer thinner, ketone or other solvents to clean the meter.

### Troubleshooting

If the meter appears to operate improperly, check the following items first.

1. Review the operating instructions to ensure the meter is being used properly.
2. Inspect and test the continuity of the test leads.
3. Make sure the battery is in good condition. The low battery symbol  appears when the battery falls below the level where accuracy is guaranteed. Replace a low-battery immediately.
4. Check the condition of the fuses if the current ranges operate incorrectly.

#### **WARNING**

**To avoid electrical shock remove the test leads from both the meter and the test circuit before accessing the battery or the fuses.**

### Battery and Fuse Replacement

See Figure 

To access the battery and the mA fuse remove the two screws holding the Battery/Fuse Cover in place, and lift the cover from the meter.

To replace the mA fuse, pry it from its clips using a small screwdriver. A spare mA fuse is located between the battery and the mA fuse.

**mA Fuse:** Fast Blow .315 A/1000 V minimum interrupt rating 30 kA (6.3 x 32 mm) (Amprobe® FP300)

To replace the 10 A fuse: 1) Remove the battery. 2) Remove the four rear-case screws. 3) Separate the case. 4) Remove the 10 A fuse cover. 5) Remove and replace the 10 A fuse. 6) Re-install the fuse cover. 7) Reassemble the meter.

**10A Fuse:** Fast Blow 10 A/1000 V, minimum interrupt rating 30 kA (10 x 38 mm) (Amprobe® FP100).

---

## Repair

All test tools returned for warranty or non-warranty repair or for calibration should be accompanied by the following: your name, company's name, address, telephone number, and proof of purchase. Additionally, please include a brief description of the problem or the service requested and include the test leads with the meter. Non-warranty repair or replacement charges should be remitted in the form of a check, a money order, credit card with expiration date, or a purchase order made payable to Amprobe® Test Tools.

## In-Warranty Repairs and Replacement – All Countries

Please read the warranty statement and check your battery before requesting repair. During the warranty period any defective test tool can be returned to your Amprobe® Test Tools distributor for an exchange for the same or like product. Please check the “Where to Buy” section on [www.amprobe.com](http://www.amprobe.com) for a list of distributors near you. Additionally, in the United States and Canada In-Warranty repair and replacement units can also be sent to a Amprobe® Test Tools Service Center (see below for address).

## Non-Warranty Repairs and Replacement – US and Canada

Non-warranty repairs in the United States and Canada should be sent to a Amprobe® Test Tools Service Center. Call Amprobe® Test Tools or inquire at your point of purchase for current repair and replacement rates.

In USA  
Amprobe® Test Tools  
Everett, WA 98203  
Tel: 888-993-5853  
Fax: 425-446-6390

In Canada  
Amprobe® Test Tools  
Mississauga, ON L4Z 1X9  
Tel: 905-890-7600  
Fax: 905-890-6866

## Non-Warranty Repairs and Replacement – Europe

European non-warranty units can be replaced by your Amprobe® Test Tools distributor for a nominal charge. Please check the “Where to Buy” section on [www.amprobe.com](http://www.amprobe.com) for a list of distributors near you.

European Correspondence Address\*  
Amprobe® Test Tools Europe  
P.O. Box 1186  
5602 BD Eindhoven  
The Netherlands

\*(Correspondence only – no repair or replacement available from this address. European customers please contact your distributor).

## WARRANTY

This 33XR-A Digital Multimeter is warranted against any defects of material or workmanship within a period of one (1) years following the date of purchase of the multimeter by the original purchaser or original user. Any multimeter claimed to be defective during the warranty period should be returned with proof of purchase to an authorized Amprobe® Test Tools Service Center or to the local Amprobe® Test Tools dealer or distributor where your multimeter was purchased. See repair section for details. Any implied warranties arising out of the sale of a Amprobe® Test Tools multimeter, including but not limited to implied warranties of merchantability and fitness for a particular purpose, are limited in duration to the above stated one (1) years period. Amprobe® Test Tools shall not be liable for loss of use of the multimeter or other incidental or consequential damages, expenses, or economical loss or for any claim or claims for such damage, expenses or economical loss. Some states do not allow limitations on how long implied warranties last or the exclusion or limitation of incidental or consequential damages, so the above limitations or exclusions may not apply to you. This warranty gives you specific legal rights, and you may also have other rights which vary from state to state.

## Specifications

### General Specifications

**Display:** 3 3/4 digit liquid crystal display (LCD)(3999 count) with a 41-segment analog bar-graph.

**Polarity:** Automatic, positive implied, negative polarity indication.

**Overrange:** (OL) or (-OL) is displayed.

**Zero:** Automatic.

**Low battery indication:** The  is displayed when the battery voltage drops below the operating level.

**Auto power off:** Approximately 30 minutes.

**Measurement rate:**

2 times per second, nominal.

**Operating environment:**

0 °C to 50 °C at <70 % R.H.

**Storage temperature:**

-20 °C to 60 °C, 0 to 80 % R.H. with battery removed from meter.

**Temperature Coefficient:**

0.1 × (specified accuracy) per °C.  
(0 °C to 18 °C, 28 °C to 50 °C).

**Environment:**

Indoor use, altitude up to 2000 m

**Power:** Single standard 9-volt battery, NEDA 1604, JIS 006P, IEC 6F22.

**Battery life:**

150 hours typical with carbon-zinc.

300 hours typical with alkaline.

**Dimensions:**

196 mm (H) × 92 mm (W) × 60 mm (D).

**Weight:**

Approximately 400 g including battery.

**Box Contents:**

The 33XR-A includes the following items:

Test leads w/ alligator clips	1 set
Holster	1
Magnet Strap	1
Temperature Adapter	1
K-type thermocouple	1
Users Manual	1
9 V battery (installed)	1
mA fuse, 0.315 A/ 1000 V	1 spare

**Approvals:**



LISTED  
950Z



**Safety:** Conforms to UL1244; EN61010- 1: Cat II – 1000V / Cat III - 600V; Class 2, Pollution degree II.

**EMC:** Conforms to EN61326-1.

This product complies with requirements of the following European Community Directives: 89/ 336/ EEC (Electromagnetic Compatibility) and 73/ 23/ EEC (Low Voltage) as amended by 93/ 68/ EEC (CE Marking). However, electrical noise or intense electromagnetic fields in the vicinity of the equipment may disturb the measurement circuit. Measuring instruments will also respond to unwanted signals that may be present within the measurement circuit. Users should exercise care and take appropriate precautions to avoid misleading results when making measurements in the presence of electronic interference.

### Electrical Specifications

(Accuracy at 23 °C ±5 °C, <75 % R.H.)

**DC VOLTS**

Ranges: 400 mV, 4 V, 40 V, 400 V, 1000 V

Resolution: 100 µV

Accuracy: ±(0.7 % of reading + 1 digit)

Input impedance: 10 MΩ

Overload protection:

400 mV Range: 1000 V dc / 750 V ac rms

(15 seconds) Other Ranges: 1000 V dc /

750 V ac rms

**AC VOLTS** (45 Hz – 500 Hz)

Ranges: 400 mV, 4 V, 40 V, 400 V, 750 V ac

Resolution: 100  $\mu$ V

Accuracy:

$\pm(1.5\%$  of reading + 4 digits)

$\pm(2.0\%$  of reading + 4 digits) 200 Hz to 500 Hz on 4 V range

Peak hold accuracy:

$\pm(3.0\%$  + 60 digits) on 40 V to 750 V ranges, 400 mV, 4 V ranges unspecified

Input impedance: 10 M $\Omega$

Overload protection: 400 mV Range:1000 V dc / 750 V ac rms (15 seconds)

Other Ranges: 1000 V dc / 750 V ac rms

**DC CURRENT**

Ranges: 400  $\mu$ A, 4 mA, 40 mA, 300 mA, 10 A

Resolution: 0.1  $\mu$ A

Accuracy:  $\pm(1.0\%$  of reading + 1 digit) on 400  $\mu$ A to 300 mA ranges

$\pm(2.0\%$  of reading + 3 digits) on 10 A range

Burden voltage:

400  $\mu$ A Range: 1 mV/ 1  $\mu$ A

4 mA Range: 100 mV/ 1 mA

40 mA Range: 12 mV/ 1 mA

300 mA: 4 mV/ 1 mA

10 A: 100 mV/ 1 A

Input protection: 0.315 A/1000 V fast blow ceramic fuse 6.3 $\times$ 32 mm on  $\mu$ A/mA input  
10 A/1000 V fast blow ceramic fuse 10 $\times$ 38 mm on 10 A input

10 A Input: 10 A for 4 minutes maximum followed by a 12 minute cooling period

**AC CURRENT** (45 Hz – 500 Hz)

Ranges: 400  $\mu$ A, 4 mA, 40 mA, 300mA, 10A

Resolution: 0.1  $\mu$ A

Accuracy:  $\pm(1.5\%$  of reading + 4 digits) on 400  $\mu$ A to 300 mA ranges

$\pm(2.5\%$  of reading + 4 digits) on 10 A range

Peak hold accuracy:  $\pm(3.0\%$  + 60 digits)

Burden voltage: See DC Current

Input protection: 0.315 A/1000 V fast blow ceramic fuse 6.3 $\times$ 32 mm on  $\mu$ A/mA input  
10 A/1000 V fast blow ceramic fuse 10 $\times$ 38 mm on 10 A input

10 A Input: 10 A for 4 minutes maximum followed by a 12 minute cooling period

**RESISTANCE**

Ranges: 400  $\Omega$ , 40 k $\Omega$ , 4 M $\Omega$

Resolution: 100 m $\Omega$

Accuracy:  $\pm(1.0\%$  of reading + 4 digits) on 400  $\Omega$ , 40 k $\Omega$  range,  $\pm(1.2\%$  of reading + 4 digits) on 4 M $\Omega$  range

Open circuit volts: 0.5 V dc typical, (3.0 V dc on 400  $\Omega$  range)

Overload protection:

1000 V dc or 750 V ac rms

**CAPACITANCE**

Ranges: 4  $\mu$ F, 40  $\mu$ F, 400  $\mu$ F, 4000  $\mu$ F

Resolution: 0.1 uF

Accuracy:

$\pm(5.0\%$  of rdg +10 digits) on 4 uF range

$\pm(5.0\%$  of rdg +5 digits) on 40 uF to 400 uF ranges

$\pm(5.0\%$  of rdg +15 digits) on 4000 uF range

Test voltage: < 3.0 V

Test Frequency: 10 Hz

Input protection: 0.315 A/1000 V fast blow ceramic fuse 6.3 $\times$ 32 mm on  $\mu$ A/mA input

**TEMPERATURE**

Ranges:-20  $^{\circ}$ C to1000  $^{\circ}$ C, -4  $^{\circ}$ F to 1832  $^{\circ}$ F

Resolution: 1  $^{\circ}$ C, 1  $^{\circ}$ F

Accuracy:

$\pm(2.0\%$  of rdg +4  $^{\circ}$ C) -20  $^{\circ}$ C to 10  $^{\circ}$ C

$\pm(1.0\%$  of rdg +3  $^{\circ}$ C)10  $^{\circ}$ C to 200  $^{\circ}$ C

$\pm(3.0\%$  of rdg + 2  $^{\circ}$ C) 200  $^{\circ}$ C to 1000  $^{\circ}$ C

$\pm(2.0\%$  of rdg + 8  $^{\circ}$ F) -4  $^{\circ}$ F to 50  $^{\circ}$ F

$\pm(1.0\%$  of rdg + 6  $^{\circ}$ F) 50  $^{\circ}$ F to 400  $^{\circ}$ F

$\pm(3.0\%$  of rdg +4  $^{\circ}$ F) 400  $^{\circ}$ F to 1832  $^{\circ}$ F

Overload protection:

1000 V dc or 750 V ac rms

**FREQUENCY** (autoranging)

Range: 4 k, 40 k, 400 k, 4 M, 1 MHz

Resolution: 1 Hz

Accuracy:  $\pm(0.1\%$  of reading + 3 digits)

Sensitivity: 10 Hz to 4MHz: >1.5 V rms;

4 MHz to 40 MHz: >2 V rms, <5 V rms

Min pulse width: >25 ns

Duty cycle limits: >30 % and <70 %

Overload protection: 1000 V dc or 750 V ac rms

## CONTINUITY

Audible indication: Less than 35  $\Omega$

Response time: 100 ms

Overload protection: 1000 V dc or 750 V ac rms

## DIODE TEST

Test current: Approximately 1.0 mA

Accuracy:  $\pm(1.5\%$  of reading + 3 digits)

Resolution: 1 mV

Audible Indication: <0.35 V

Open circuit volts: 3.0 V dc typical

Overload protection: 1000 V dc or 750 V ac rms

## ADDITIONAL FEATURES

**mA, 10 A** lead connection: Beeps to warn test leads are connected to measure current while Function/Range Switch is not set to a measure current.

**MIN MAX:** Displays the minimum or maximum value detected while making a measurement.

**PEAK  $\pm$ :** Displays the peak+ or peak- value in an AC voltage or AC current measurement.

Response time: more than 1 ms

**HOLD:** Holds the latest reading on the display.

**REL:** Execute relative mode.

**Auto Power off:** 30 minutes, typical

## REPLACEMENT PARTS

TL36	Test Lead Set with Alligator clips
FP300	mA fuse - Fuse Pack .315 A/1000 V (4 each)
FP100	10 A fuse - Fuse Pack 10 A/1000 V (2 each)
XR-TA	Input Adapter for K-type thermocouple
TP255	K type thermocouple

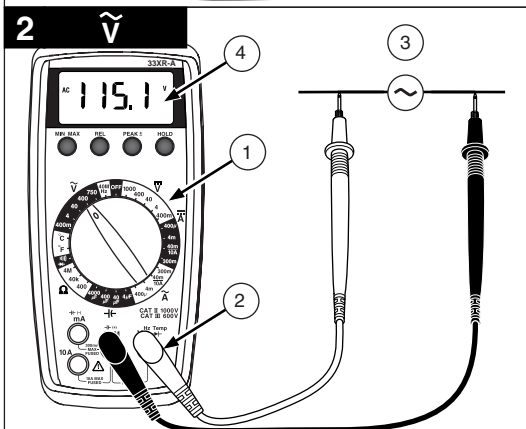
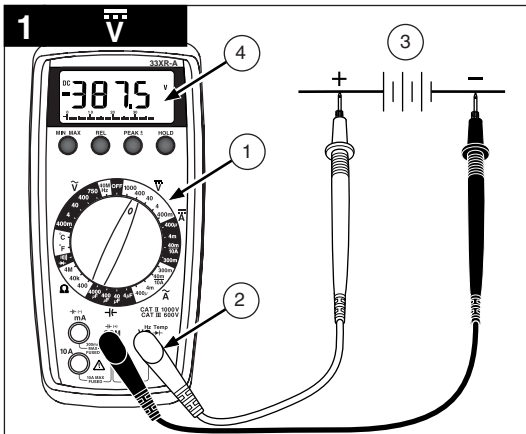

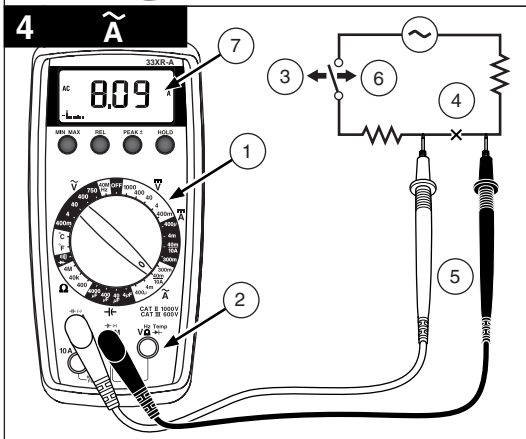
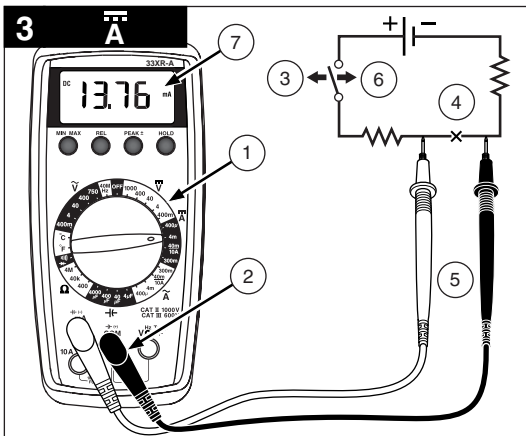

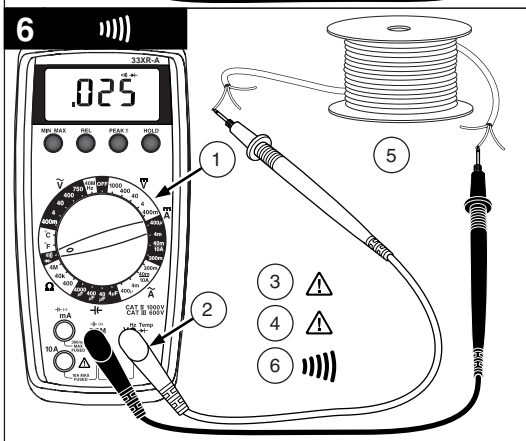
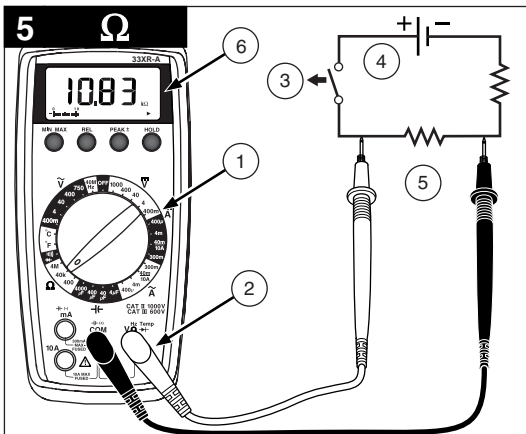

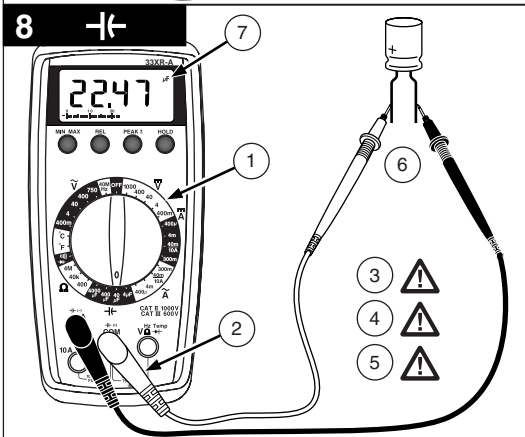
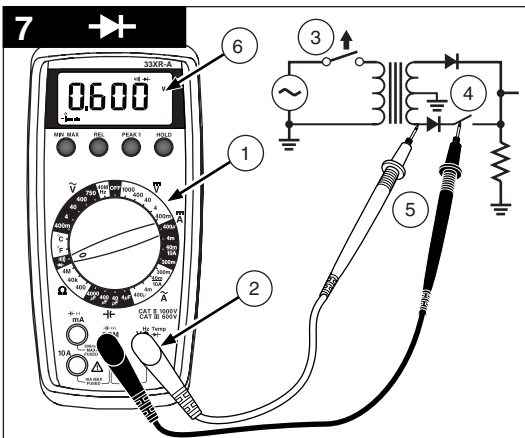



11  / 

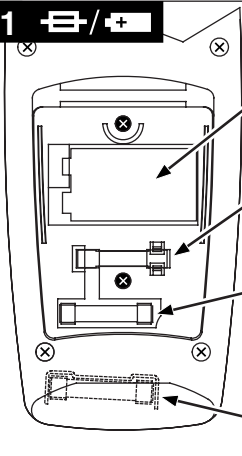

⊗ (2)

9 V Battery  
Pile 9 V  
9 V Batterie  
Pila de 9 V  
Batería de 9 V

Spare 315 mA fuse  
Fusible 315 mA de rechange  
315 mA Ersatzsicherung  
Fusibile di ricambio da 315 mA  
Fusible de recambio de 315 mA

315 mA Fuse  
Fusible 315 mA  
315 mA Sicherung  
Fusibile da 315 mA  
Fusible de 315 mA

⊗ (2) ⊗ (4)

10 A Fuse  
Fusible de 10 A  
10 A Sicherung  
Fusibile da 10 A  
Fusible de 10 A

